

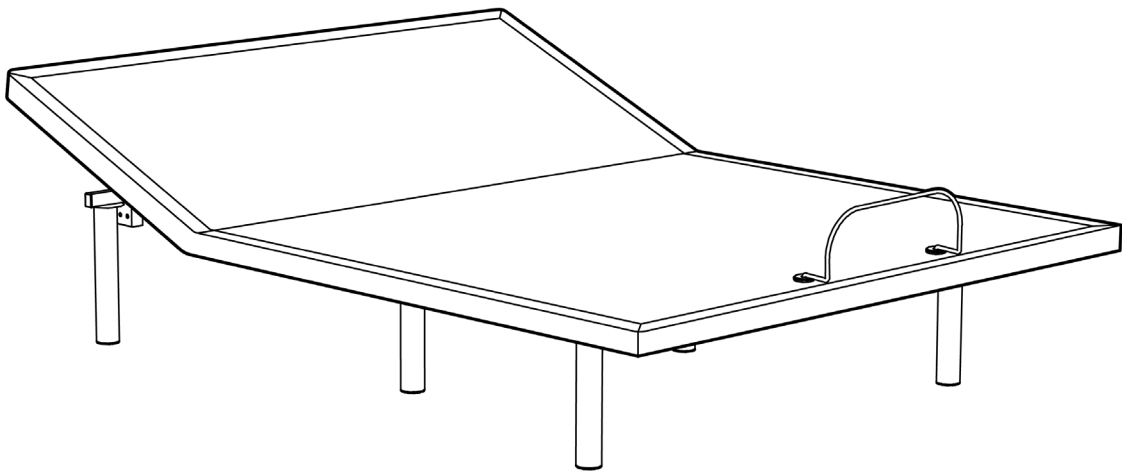

**Adjustable Power Base
4MM™ Owners Manual**



*Image may not represent the product you purchased

CONGRATULATIONS ON YOUR PURCHASE OF A REVERIE POWER BASE!

Please take a moment to follow the below steps to ensure the correct set-up (or pairing) of your remote.

Step 1: Install batteries in your remote before use.

Step 2: Contact our customer service at 1-800-973-8374 or customerservice@reverie.com if you need any additional assistance.

Your base comes with a 20 Year Limited Warranty. For a Full Owners Manual, Warranty, and Troubleshooting information, please visit our website at: <https://reverie.com/support>

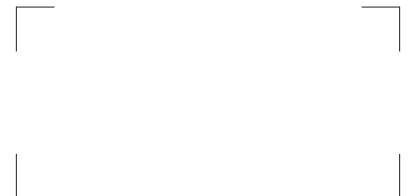

WARNING! IMPORTANT SAFETY INSTRUCTIONS. PLEASE READ THESE INSTRUCTIONS THOROUGHLY BEFORE USING THIS PRODUCT. SAVE THESE INSTRUCTIONS!

When using an electrical furnishing basic precautions should always be followed, including the following:

READ ALL INSTRUCTIONS BEFORE USING (THIS FURNISHING)

DANGER: To reduce the risk of electric shock: Always unplug this furnishing from the electrical outlet before cleaning.

WARNING:

To reduce the risk of burns, fire, electric shock, or injury to persons:

- Unplug from outlet before putting on or taking off parts.
- Close supervision is necessary when this furnishing is used by or near children, invalids or disabled persons.
- Use this furnishing only for its intended use as described in these instructions. Do not use attachments not recommended by the manufacturer.
- Never operate this furnishing if it has a damaged cord or plug, or if it is not working properly, dropped or damaged, or dropped into the water, call Reverie customer service.
- Keep the cord away from heated surfaces.
- Never drop or insert any object into any opening.
- Do not use outdoors.
- Do not operate where aerosol (spray) products are being used or where oxygen is being administered.
- To disconnect, turn all controls to the off position, then remove plug from outlet.

WARNING: Risk of Injury: Keep children away from under the head and foot of the base when moving.

WARNING: Risk of electric shock: Connect this furnishing to a properly grounded outlet only.

GROUNDING INSTRUCTIONS:

This product must be grounded. If it should malfunction or breakdown, grounding provides a path of least resistance for electric current to reduce the risk of electric shock. This product is equipped with a cord having an equipment-grounding conductor and a grounding plug. The plug must be plugged into an appropriate outlet that is properly installed and grounded in accordance with all local codes and ordinances.

DANGER:

Improper connection of the equipment-grounding conductor can result in a risk of electric shock. Check with a qualified electrician or serviceman if you are in doubt as to whether the product is properly grounded.

Do not modify the plug provided with the product. If it will not fit the outlet, have a proper outlet installed by a qualified electrician.

FOR BEST RESULTS, YOUR POWER BASE SHOULD BE PLUGGED INTO A SURGE PROTECTOR (not included).

This product is for use on a circuit having a standard rating of 120 volts and is factory equipped with a specific electric cord and plug to permit connection to a proper electric circuit. Make sure that the product is connected to an outlet having the same configuration as the plug. No adapter should be used with this product. If the product must be reconnected for use on a different type of electric circuit, the reconnection should be made by qualified service personnel.

Unauthorized modifications could void the electrical portion of your warranty. Failure to use a properly grounded outlet for this product or modification of the plug will compromise this important grounding safety feature and may result in electrical shock, electrical fire, or faulty operation of the product.

WARNING: PINCH POINT! Do not reach under the base during operation.

WARNING!

DO NOT USE NEAR PEOPLE USING OR WEARING MEDICAL DEVICES. FOR HOUSEHOLD / RESIDENTIAL USE ONLY. DO NOT USE OUTDOORS. This product conforms to UL STD 962

IMPORTANT SAFETY FEATURES:

Use this furnishing only for its intended use as described in these instructions. Do not use attachments not recommended by the manufacturer. If there is an overload weight condition on the head or foot mechanism, the control unit will automatically stop all functions. Once the excess weight is removed the control unit will automatically allow all functions to resume operation after 30 seconds. As with any product that produces a vibrating motion, it is possible that some pacemakers may interpret this motion as a false sense of movement and or exercise. This may or may not affect your pacemaker. If you have any concerns, please consult your physician. For more information please contact customer service by calling **800-973-8374**.

USER-SERVICEABLE PARTS:

This product is specifically designed to have no maintenance by you, the user. Therefore, you are encouraged not to open any motors, alter the wiring, adjust, modify or change the structure of the product, as it will void the warranty.

POWER RATINGS:

INPUT: AC 100-240V - 50/60Hz, 1.5 Amp
OUTPUT: DC 29V-2.24A

WARNING: DO NOT USE RECHARGEABLE BATTERIES IN THE CONTROL BOX OR POWER SUPPLY FOR THE EMERGENCY POWER DOWN FEATURE.

IN-HOME USE AND HOSPITAL DISCLAIMER:

Your power base is strictly designed for in-home use only. It is NOT designed for hospital use and is NOT designed to meet hospital standards. Do not use this base with TENT TYPE oxygen therapy equipment or near explosive gases.

SMALL CHILDREN AND PETS WARNING:

After your Power Base has been unboxed, immediately dispose of packaging as it can smother small children and pets. To avoid injury, children and pets should not be allowed to play on or under the power base.

Children should not operate this product without adult supervision. Close supervision is necessary when this furnishing is used by, or near children, invalids, or disabled persons.

SAVE THESE INSTRUCTIONS:

Your Power Base has been designed to provide you with the reliable operation and durability you expect. This product has been inspected and tested prior to shipment.

For best performance, you should enter and exit the Power Base while it is in the flat or fully lowered position.

DO NOT SIT ON THE HEAD OR FOOT SECTIONS WHILE IN THE RAISED POSITION.

INTENDED USAGE

The electric power base should be installed with the head board brackets and/or the head of the frame positioned close to a wall.

PRODUCT RATINGS

The lift motor in your Power Base is NOT designed for continuous use. Reliable operation and full life expectancy will be attained as long as the lift motor does not operate more than two (2) minutes over an eighteen (18) minute period, or approximately 10% duty cycle. Any attempt to circumvent or exceed this rating will shorten the life expectancy of this product and may void the warranty. The recommended weight restrictions for your Power Base is up to 850 lbs. total weight, including people and the mattress for all sizes of power bases. Lift speed will vary due to weight and mattress configuration, as well as the mattress type. The weight must be evenly distributed across the power base. This Product is not designed to support or lift 850 lbs of total weight in the head or foot sections of your Power Base alone, or in any unevenly distributed fashion. Some mattresses are not designed for Power Bases because they do not bend or flex well when adjusted. When using such a mattress with your Power Base the weight limits set forth herein do not apply, as the bending of the mattress requires significant force and puts significant strain on the motors and the Power Base itself.

WARRANTY PRECAUTION:

Do not open control box, motors or wireless remote controls (with the exception of the battery compartment if equipped). The warranty is void if these units are tampered with. Any repair or replacement of power base parts must be performed by an authorized technician.

Note: Exceeding the recommended weight restrictions could damage your power base and void your warranty and using a mattress on top of your power base that is not designed for adjustability may also void your warranty.

IMPORTANT UNPACKING INSTRUCTIONS

To avoid damage to the power base, always open the carton while the power base is laying in the FLAT position on the floor.

OPEN FLAT

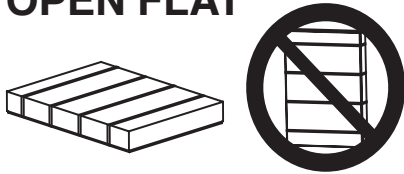

Package contents:

Remote Control
 Mattress Retainer Bar
 Power Adapter
 Base Legs
 Y-cable (optional for Tandem control)

STEP 1

Carefully pull the folded power base unit out of the shipping carton. Remove and discard the plastic bag. Unfold the base keeping the unit top side down. For safety reasons, this should be performed by 2 people.

WARNING: PACKAGING MATERIAL MAY SMOTHER SMALL CHILDREN AND PETS

STEP 2

Remove the securing fasteners on the accessory components, and set them aside from the undercarriage of the base.

STEP 3

Remove the zip ties securing the excess cord from the motors of the power base.

STEP 4A

If the power base is supposed to be used on a platform or storage bed without legs, carefully flip the power base over with at least 2 people and place it on top of the platform. Make sure that none of the cords are getting crushed between the power base and the platform bed. (For non-platform setup, skip to Step 4B.)

WARNING: Check with your platform frame's manufacturer to ensure that the frame can support the additional weight of the power base. Reverie will not be responsible for damage caused to your platform frame.

STEP 4B

If the base is going to be used independently, assemble the power base legs. Screw them in a clockwise direction into the threaded holes in the frame. Carefully flip the power base over with at least 2 people, to the upright position.



ATTENTION! Improper handling

DO NOT lean the power base against the installed legs to flip it over.



STEP 5

Plug the power cord into a grounded electrical outlet.

WARNING: POWER CORDS MUST NOT INTERFERE WITH ANY POWER BASE MECHANISMS

NOTE: An electrical surge protection unit is recommended (**not included**)

STEP 6

Insert the mattress retainer bar into the two mount holes located at the foot end of the power base.

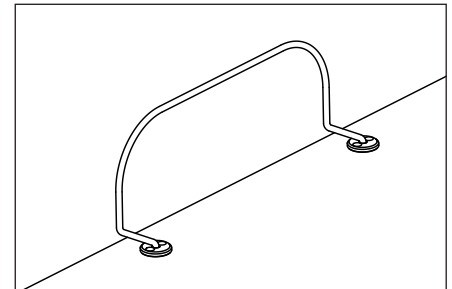

STEP 7

If you are installing a headboard, proceed to follow the Headboard Bracket Assembly Guide on our website. If not, place your mattress on top of the power base. Power base assembly is now complete.

Register Online. For easy registration of your warranty visit <https://reverie.com/register-your-warranty>

Please prepare a digital copy of your proof of purchase (invoice or sales receipt) when registering online. You may be required to provide the Serial Number for registration, you can find it on the Law Tags attached to the base.

Manufactured by Reverie®
 For Warranty and Service:
 1-800-973-8374
 customerservice@reverie.com
 Please have your receipt ready and available.

Thank you and enjoy your power base.
www.reverie.com

IF YOU HAVE A WIRELESS REMOTE

Your remote is already paired with your power base. Follow the below instructions for replacement remote pairing.

STEP 1

Place batteries into the remote control (3 x AAA batteries).

STEP 2

Ensure the power base is plugged into a functioning outlet.

STEP 3

Press and hold the pairing button on the control box until the indication light blinks.

STEP 4

Press any button on the remote control. When the control box light turns solid, the remote should be successfully paired.

STEP 5

Test and verify the remote is correctly paired by activating functions of the power base. You have now completed the pairing process.

How To Unpair a Remote

To unpair a remote, simply pair another remote twice, to unpair the previously paired remote.

IF YOU HAVE A WIRED REMOTE

If you have a wired remote and want to connect to 2 power bases that will move in tandem as a single unit, follow the below instructions. For reference, bases will be referred to as “Base A” and “Base B”, but are not actually label as such in person.

STEP 1

Make sure both Base A and Base B are set up and positioned closely side-by-side together. (Ignore this step for Split Top Queen setup. For the following steps, Base A/B will refer to Side A/B).

STEP 2

Unplug both wired remote controls from their lift motors and set aside.

STEP 3

Remove and extend one of the provided Y-Cables.

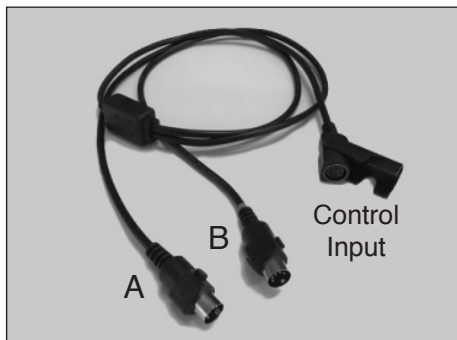

STEP 4

Plug in the “A” output of the Y-Cable into Base A control port.

STEP 5

Plug in the “B” output of the Y-Cable into Base B control port.

STEP 6

Plug one of the provided hardwired remote controls into the “Control Input” side of the Y-Cable.

STEP 7

Route the control cable to your preferred side of the bed.

Emergency Power Down Feature

Your power base has an emergency lowering feature in the event that your power base is in the raised position and has lost power due to a power outage.

STEP 1

Locate and remove the cover for the 9 volt batteries on the control box or power supply box.

STEP 2

Install the two (2) alkaline 9 volt batteries and reinstall the battery cover.

WARNING: DO NOT USE RECHARGEABLE BATTERIES IN THE CONTROL BOX OR POWER SUPPLY FOR THE EMERGENCY POWER DOWN FEATURE.

STEP 3

Press the “FLAT” button or the individual lowering buttons.

STEP 4

Once the bed returns to the flat position, remove the batteries from the Control box.

NOTE: DO NOT raise the base when powered with only backup batteries. The batteries are only intended to lower the base in case of emergency.

Remote Control Operation Guide

HEAD AND FOOT ADJUSTMENTS (A,C)

Adjusts the head and foot sections to the desired positions.

FLAT (B)

Returns both head and foot to the flat position.

ZERO GRAVITY (D)

Allows your legs to be lifted to a position slightly above the chest, which enables blood flow to easily circulate back to the heart, thus reducing stress and fatigue.

MEMORY POSITION PRESETS (E,F)

You can store 2 personalized memory positions. Press and hold the Memory button for 5 seconds until the LED light flashes 3 times to store the setting. To recall a Memory Position, press the corresponding button.

NOTE: Do not hold the memory position for more than 5 seconds or the setting will overwrite.

ANTI SNORE (G)

Raises the HEAD slightly for easier breathing.

HEAD AND FOOT MESSAGE CONTROLS (H,J)

Turns on the corresponding message unit and slowly increases or decreases message intensity.

NOTE: The message feature is designed to automatically shut off after 30 minutes of continuous use.

MESSAGE STOP (I)

Press to stop all message features.

A. RAISE & LOWER HEAD SECTION _____

B. FLAT _____

C. RAISE & LOWER FOOT SECTION _____

D. ZERO GRAVITY _____

E. MEMORY POSITION 1 _____

F. MEMORY POSITION 2 _____

G. ANTI - SNORE _____

H. HEAD MESSAGE INTENSITY _____

I. STOP MESSAGE _____

J. FOOT MESSAGE INTENSITY _____

K. FULL BODY MESSAGE _____

L. WAVE MESSAGE PATTERNS _____



NOTE: The lowest setting will turn off the corresponding message unit.

REMOTE LOCKOUT FEATURE (A,B)

We created the remote lockout feature to help owners prevent unintended use of the base.

Activating Remote Lockout

At the same time, press and hold the HEAD UP and FLAT buttons for 3 seconds. The LED will flash twice to indicate activation. Pressing any buttons on the remote while in lockout mode will result in no movement from the power base.

Deactivating Remote Lockout

Repeat the same process, press and hold the HEAD UP and FLAT buttons at the same time for 3 seconds. The LED will flash twice to indicate deactivation. The remote and power base will work normally.

FULL BODY MESSAGE (K)

Turns the Head and Foot Message units on at the same time.

WAVE MESSAGE PATTERN (L)

Turns on both head and foot message motors to 3 different wave presets.

NOTE: Any control button on the remote will interrupt and stop the FLAT, ZERO-G, Anti-Snore and Memory Position presets.

ADDITIONAL REMOTE FEATURES:

- The buttons are back-lit when a button is pressed, to aid the visibility of the remote in low light environments.
- This Base uses a RF (Radio Frequency) remote control system.
- The included remote is already paired with your power base, so should be operational right out of the box. Please test some of the features to ensure functionality.
- Only replacement remote controls require pairing instruction on following pages. If you find that your remote is not paired with the bed, please follow those Bluetooth pairing instructions.

NOTE: This power base may have minor intermittent performance due to RF Interference. This is a normal operation of the power base and is not a defect.

NOTE: Please remember to recycle all electronics.

NOTICE: Changes or modifications not expressly approved by the party responsible for compliance could void the user's authority to operate the equipment.

IMPORTANT NOTE:

To comply with the FCC RF exposure compliance requirements, no change to the antenna or the device is permitted. Any change to the antenna or the device could result in the device exceeding the RF exposure requirements and void user's authority to operate the device.

NOTE: This device complies with part 15 of the fcc rules. Operation is subject to the following two conditions: (1) This device may not cause harmful interference (2) This device must accept any interference received, including interference that may cause undesired operation.

How to Download the App Software

STEP 1

Use your iOS mobile device to log into the APP STORE.

STEP 2

Type “**Reverie Nightstand**” in the search column.

STEP 3

Select the Reverie Nightstand app.

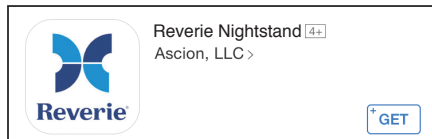

STEP 4

Click install to download the app.

NOTE: Once the App is installed, when you open the app the Bluetooth module will connect to your device automatically.

NOTE: Make sure the Reverie Nightstand App is the last app open on your phone before locking (putting your phone in sleep mode)

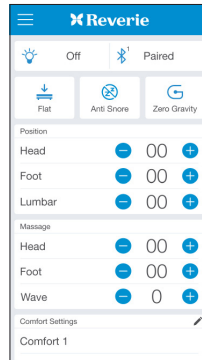

Dashboard/Home Screen

- Condensed versions of key features, functions and settings are accessible and controllable from the Dashboard - Nightlight, Bluetooth status, Reverie Presets, Position control, Massage control, Comfort Settings, Routines, Memory Positions, Alarms
- The Dashboard and each Preset Section is customizable to display your favorite and most used settings.
- Expandable Toolbar gives access to all app features - Dashboard, Position, Massage, Presets, Alarms, and Settings
- Nighttime Mode - Change the color scheme of the app to better suit nighttime use.

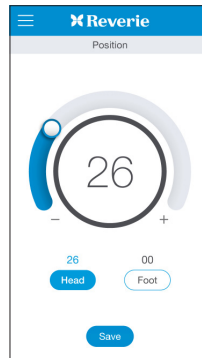

Position Control

- Control your head and foot elevation.
- Adjust your base using the Slider or press/hold the plus or minus symbols for micro adjustments.
- Switch between each adjustment (Head, Foot, Other) and view all settings above each button.
- Save your current position and/or massage setting as a new Comfort Setting.

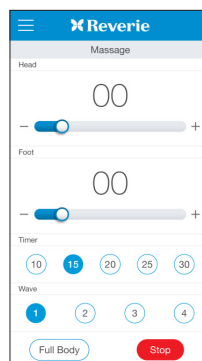

Massage

- Control your massage intensity using the Slider or press/hold the plus or minus symbols for micro adjustments.
- Full body - Turns on the full body function.
- Wave - Select one of 4 different wave functions
- Timer - Select your desired massage duration.
- Stop - Turns the massage off.

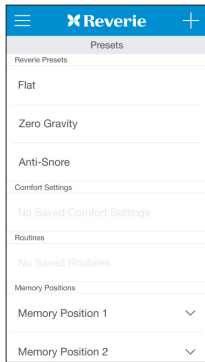

Presets

- Reverie Presets - Zero Gravity, Anti-Snore, and Flat.
- Comfort Setting - Press “+” to program a unique head, foot and/or massage combination.
- Routines - Press “+” to program a set of saved comfort settings into a series of timed positions.
- Memory Positions - Access and overwrite previously saved Memory Positions from your remote control.
- View details of each setting with the expand arrow as well as Edit and Delete.

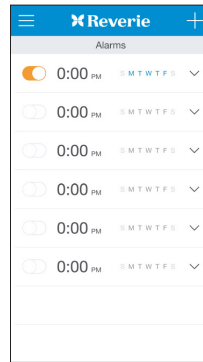

Alarm

- Create an alarm setting to raise and/or massage you awake.
- Press “+” to create a new alarm setting.
- Set time - Scroll to select the hour, minute and day.
- Repeat - Select the days of the week you would like the alarm to activate.
- Assign - Select a comfort setting or routine to assign the alarm to.

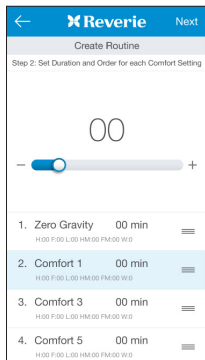

Routines

- Select which Comfort Settings you want to use to create a new Routine.
- Set the order of these Comfort Settings and the duration of each.
- Save your new Routine.

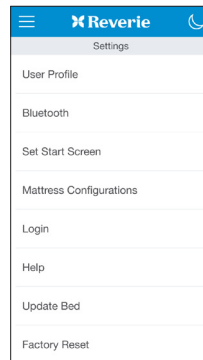

Settings

- Customize your app in settings.
- User Profile - Define your user profile to - The “Power Base” field is required and is important to allow the app to best represent your specific power base.
- Bluetooth - Shows the bed your app is connected to. Shows nearby beds that you can connect to in order of proximity.
- Reverie Connect - If your base is compatible with our Reverie Connect technology you can follow the setup to control your base with 9 voice activated commands
- Set Start Screen - Set what screen you want the app to open up to.
- Mattress Configurations - Reconfigure your Reverie Dream Supreme mattress with these firmness guides.
- Login/Logout - Log in to your account
- Help - Contact info for technical support.
- Update Bed - Update the software on your control box
- Factory Reset - Reset your app to original settings.

Android App User Guide

How to Download the App Software

STEP 1

Use your Android mobile device to log into the GOOGLE PLAY STORE.

STEP 2

Type “**Reverie Nightstand**” in the search column.

STEP 3

Select the Reverie Nightstand app.



STEP 4

Click install to download the app.

NOTE: When you open the app the Bluetooth module will connect to your device automatically.

NOTE: Make sure the Reverie Nightstand App is the last app open on your phone before locking (putting your phone in sleep mode)

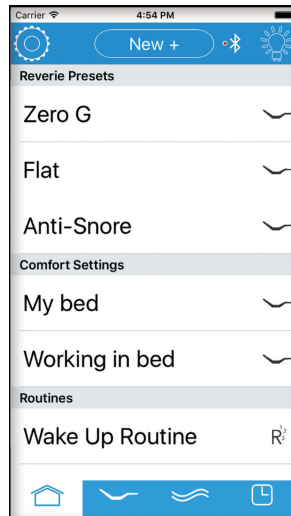

Home Screen

- Key features, functions and settings are accessible from the home screen.
 - Settings, Preset List, Comfort Settings, Routines, Bluetooth, Nightlight, Home Tab, Position Tab, Massage Tab, and Alarm Tab.
- Reverie Presets - Zero Gravity, Anti-Snore, and Flat are right at your fingertips.
- Comfort Setting - Press “New +” to program a unique head, foot and/or massage combination.
- Routines - Press “New +” to program a set of saved or new comfort settings into a series of timed positions.

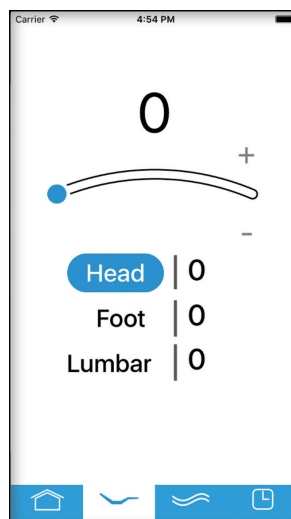

Position Control

- Control your head and foot elevation.
- Select the part of the bed you would like to elevate or lower (head or foot).
 - Use your finger to slide the blue dot along the curve to your desired elevation or press and hold the plus or minus symbol to adjust elevation.
- Your position on a scale of 1-100 will appear at the top of the screen and next to the head or foot position.

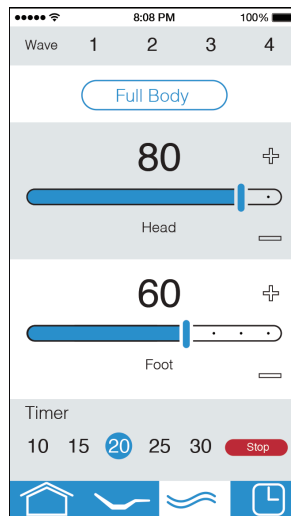

Massage

- Control your massage intensity and duration.
- Full body - Turns on the full body function.
- Wave - Select number of alternating pulses at the head and foot of the bed.
- Head and Foot control - Select massage intensity in the head and foot sections of the bed.
 - Use your finger to slide the blue button to your desired intensity or press and hold the plus or minus symbol to adjust intensity.
- Timer - Select your desired massage duration.
- Stop - Turns the massage off.

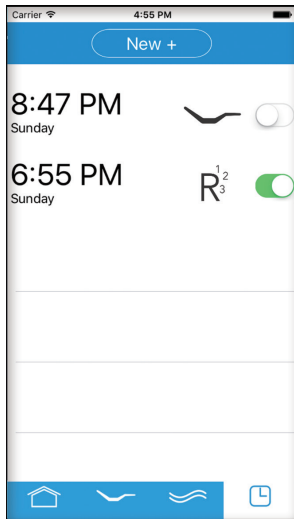

Alarm

- Create an alarm setting to raise and/or message you awake.
- Press “New +” to create a new alarm setting.
 - Set time - Scroll to select the hour, minute and day.
 - Repeat - Select the days of the week you would like the alarm to activate.
 - Bed control - Select nothing or select a new or existing comfort setting or routine.
 - Snooze - Enable snooze.

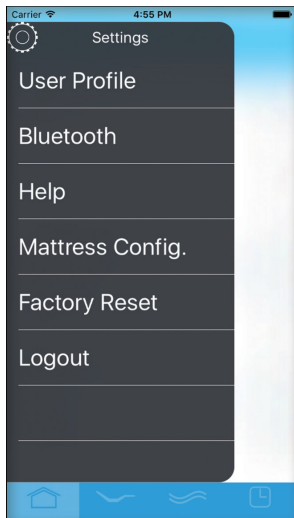

Settings

- Customize your app in settings.
- User Profile - Define your user profile to get recommendations on custom settings for you.
- Bluetooth - Shows the bed you are connected to and shows nearby beds that you can connect to in order of proximity.
- Help - Contact info for technical support.
- Mattress Configurator - Reconfigure your Reverie Dream Supreme mattress with these firmness guides.
- Factory Reset - Reset your app to original settings.
- Logout - Logout or create a new user.

Headboard Bracket Assembly

PARTS LIST

- A. Inner Headboard Brackets (2)
- B. Outer Headboard Brackets (2)
- C. Headboard Bracket Bolts (12)
- D. Washers (24)
- E. Lock Nuts (12)
- F. Wrench (1)
- G. Allen Key (1)

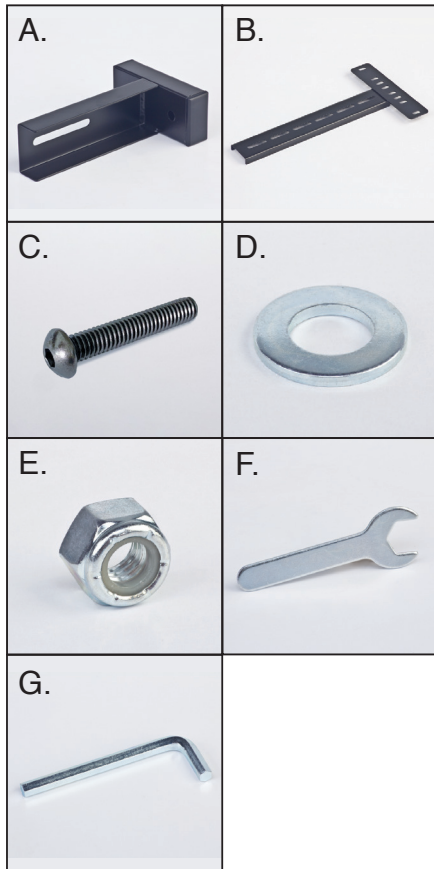

Prepare the headboard brackets for installation onto your power base by placing one set of brackets on the left-hand side of the base, and one set of brackets on the right-hand side of the base.

STEP 1

Use the remote control to raise the head of the base in order to gain access to the power base frame.

STEP 2

Bolt an Inner Headboard Bracket (A) to the headboard mount tube (located on the steel frame crossbar) using 2 Headboard Bracket Bolts (C), 4 Washers (D), and 2 Lock Nuts (E). Do not tighten the bolts to allow for adjustment later.

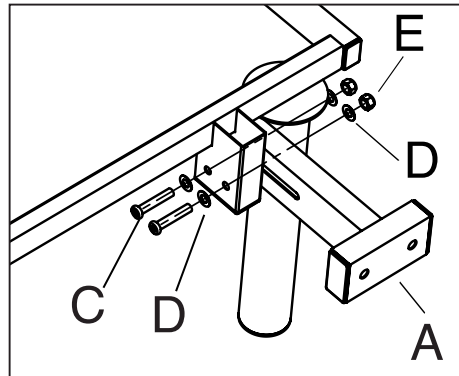

STEP 3

Place the open side of the Outer Headboard Bracket (B) onto the exposed square tube of the Inner Headboard Bracket (A). This will create a tight fit between (A) and (B). Place 2 Headboard Bracket Bolts (C) with a Washer (D) through the Outer Headboard Bracket (B) and into the Inner Headboard Bracket (A). Thread a Lock Nut (E) with a Washer (D) onto the bolts. Do not tighten the bolts to allow for adjustment later.

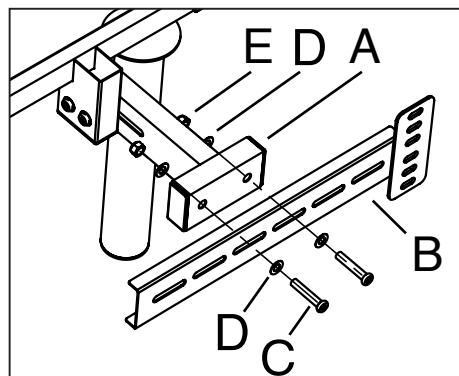

STEP 4

Lower the head section of your power base. Check that there is sufficient distance between the edge of the power base and the Outer Headboard Brackets (B).

If the distance needs to be adjusted, make an adjustment to the position of the Inner Headboard Bracket (A). Now tighten the bolts from step 2, attaching it to the frame.

Repeat steps 2-4 for the opposing side's brackets, making the distance equal to the one above.

STEP 5

On your headboard's legs, measure the distance between the center of each leg's mounting holes. Write down this measurement.

On the Outer Headboard Brackets (B), measure the distance between the center of each bracket's mounting holes. Write down this measurement.

The measurement from the Outer Headboard Bracket (B) holes must be equal to the measurement from the headboard's leg mounting holes. If needed, adjust the position of the Outer Headboard Brackets (B) so that the mounting holes are equal to the legs. Now tighten the bolts from step 3.

STEP 6

Through the mounting holes in your headboard, fasten your headboard to the Outer Headboard Brackets (B) using the Headboard Bracket Bolts (C). Assembly is now complete.

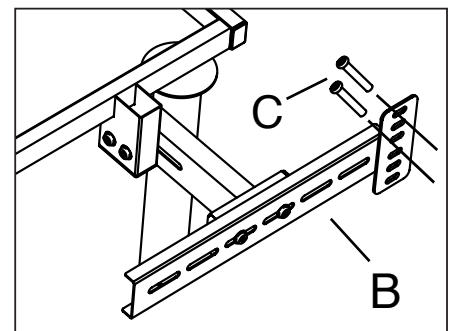

Troubleshooting

In the event the Power Base fails to operate, investigate the symptoms and possible solutions provided in the chart below:

SYMPTOM	SOLUTION
<p>No features of the Power Base will activate.</p>	<ul style="list-style-type: none"> • Make sure your remote is paired or plugged into the bed. • Your electrical circuit breaker may be tripped. • Verify the power cord is plugged into a working, grounded electrical outlet. <i>A grounded, electrical surge protection device is recommended.</i> Test the outlet by plugging in another working appliance. • This may be due to overload condition, remove the load and put the bed into the flat position and then move it all the way to maximum position to test that the functions are fully operational.
<p>Head or foot section will elevate but will not return to the horizontal (flat) position.</p>	<ul style="list-style-type: none"> • The power base mechanism may be obstructed. Elevate the power base and check for an obstruction. Remove the obstruction. • The head section may be too close to the wall. The headboard may be too close to the edge of the mattress. Adjust if required.
<p>Lift function has minor interference during operation.</p>	<ul style="list-style-type: none"> • There may be an overload of weight on your bed. • Press the lift buttons squarely & accurately. • The power base mechanism may be obstructed. Elevate the power base and check for an obstruction. Remove the obstruction.
<p>Excessive massage motor noise.</p>	<ul style="list-style-type: none"> • Make sure the massage motor cable is not loose and hitting the base structures. • Verify that the bed is not positioned against a wall, nightstand, or other object that may cause the vibration or noise. • If this base is installed over a bed frame, verify the massage motors are not causing the bed frame (or bed frame components) to vibrate. • Verify that the headboard attachment hardware is firmly tightened.
<p>Noise when operating the bed.</p>	<ul style="list-style-type: none"> • Check for obstructions under the bed. • The actuators make a light noise during operation, this does not indicate any defect. • Squeaking noise could be caused by a loose bolt. Identify and tighten the bolt. • If no solution can be found please call Customer Service.

Troubleshooting

Remotes only

SYMPTOM	SOLUTION
Remote Lockout Feature not working.	<ul style="list-style-type: none">• Make sure you are correctly pressing both specified buttons at the same time.• Verify that the remote has battery power.• Make sure there are no other devices causing RF interference with the remote.• If cannot determine then please call customer service.
Remote readout doesn't match actual bed position.	<ul style="list-style-type: none">• Recalibrate by pressing FLAT on the remote, then lift all sections to maximum position until it shows 100 on the remote screen.
Remote states "No Bed Paired".	<ul style="list-style-type: none">• Allow the remote to go back to sleep by setting down, check if its connected after 3 minutes.• If not resolved, go through the pairing process again.
Distorted image on the remote screen.	<ul style="list-style-type: none">• Let the remote go back to sleep and wake it up again. Repeat this multiple times. If problem persists, contact customer service.
Remote states PLC battery error.	<ul style="list-style-type: none">• Please call Customer Service.
Remote states other remote connected.	<ul style="list-style-type: none">• Either your phone is connected to the bed via the Reverie Nightstand app or another remote is connected. Disconnect from bluetooth in the app and make sure the other remote is asleep.